

Edge[®] 810

Owner's Manual



All rights reserved. Under the copyright laws, this manual may not be copied, in whole or in part, without the written consent of Garmin. Garmin reserves the right to change or improve its products and to make changes in the content of this manual without obligation to notify any person or organization of such changes or improvements. Go to www.garmin.com for current updates and supplemental information concerning the use of this product.

Garmin®, the Garmin logo, Auto Lap®, Auto Pause®, City Navigator®, Edge®, and Virtual Partner® are trademarks of Garmin Ltd. or its subsidiaries, registered in the USA and other countries. ANT+™, BaseCamp™, Garmin Connect™, and GSC™ are trademarks of Garmin Ltd. or its subsidiaries. These trademarks may not be used without the express permission of Garmin.

The Bluetooth® word mark and logos are owned by the Bluetooth SIG, Inc. and any use of such marks by Garmin is under license. Mac® is a registered trademark of Apple Computer, Inc. microSD™ is a trademark of SD-3C, LLC. New Leaf® is a registered trademark of the Angeion Corporation. Training Stress Score™ (TSS), Intensity Factor™ (IF), and Normalized Power™ (NP) are trademarks of Peakware, LLC. Windows® is a registered trademark of Microsoft Corporation in the United States and other countries. Other trademarks and trade names are those of their respective owners.

This product is ANT+™ certified. Visit www.thisisant.com/directory for a list of compatible products and apps.

Table of Contents

Introduction	1	Navigation	9
Getting Started.....	1	Locations.....	9
Charging the Device.....	1	Saving Your Location.....	9
About the Battery.....	1	Saving Locations from the Map.....	9
Installing the Standard Mount.....	1	Navigating to a Location.....	9
Installing the Out-Front Mount.....	1	Navigating to Known Coordinates.....	9
Releasing the Edge.....	2	Navigating Back to Start.....	9
Turning On the Device.....	2	Stopping Navigation.....	9
Keys.....	2	Projecting a Location.....	9
Acquiring Satellite Signals.....	2	Editing Locations.....	10
Training	3	Deleting Locations.....	10
Going for a Ride.....	3	Route Settings.....	10
Alerts.....	3	Selecting an Activity for Route Calculation.....	10
Setting Range Alerts.....	3	Purchasing Additional Maps.....	10
Setting a Recurring Alert.....	3	Finding an Address.....	10
Workouts.....	3	Finding a Point of Interest.....	10
Following a Workout From the Web.....	3	Finding Nearby Locations.....	10
Creating a Workout.....	3	Topographical Maps.....	10
Repeating Workout Steps.....	4	Map Settings.....	10
Starting a Workout.....	4	Advanced Map Settings.....	10
Stopping a Workout.....	4	Changing the Map Orientation.....	10
Editing a Workout.....	4	Customizing Your Device	11
Deleting a Workout.....	4	Profiles.....	11
Using Virtual Partner®.....	4	Updating Your Bike Profile.....	11
Courses.....	4	Updating Your Activity Profile.....	11
Creating a Course on Your Device.....	4	Setting Up Your User Profile.....	11
Following a Course From the Web.....	4	About Lifetime Athletes.....	11
Tips for Training with Courses.....	4	Bluetooth Settings.....	11
Displaying a Course on the Map.....	4	About Training Settings.....	11
Changing the Course Speed.....	5	Customizing the Data Pages.....	11
Stopping a Course.....	5	Using Auto Pause.....	11
Deleting a Course.....	5	Marking Laps by Position.....	12
Personal Records.....	5	Marking Laps by Distance.....	12
Restoring Your Personal Records.....	5	Using Auto Scroll.....	12
Training Zones.....	5	Changing the Start Notice.....	12
Setting Your Speed Zones.....	5	System Settings.....	12
ANT+ Sensors	5	GPS Settings.....	12
Putting On the Heart Rate Monitor.....	5	Display Settings.....	12
Setting Your Heart Rate Zones.....	5	Data Recording Settings.....	12
About Heart Rate Zones.....	6	Changing the Units of Measure.....	12
Fitness Goals.....	6	Changing the Configuration Settings.....	13
Installing the GSC 10.....	6	Changing the Device Language.....	13
About the GSC 10.....	6	Setting the Device Tones.....	13
Data Averaging for Cadence or Power.....	6	Time Zones.....	13
Training with Power Meters.....	7	Device Information	13
Setting Your Power Zones.....	7	Specifications.....	13
Calibrating Your Power Meter.....	7	Edge Specifications.....	13
Pairing Your ANT+ Sensors.....	7	Heart Rate Monitor Specifications.....	13
Pairing a Heart Rate Monitor.....	7	GSC 10 Specifications.....	13
Using the Weight Scale.....	7	Device Care.....	13
History	7	Cleaning the Device.....	13
Viewing Your Ride.....	7	Caring for the Heart Rate Monitor.....	13
Viewing Data Totals.....	7	Heart Rate Monitor Battery.....	13
Sending Your Ride to Garmin Connect.....	7	Replacing the Heart Rate Monitor Battery.....	13
Garmin Connect.....	8	Replacing the GSC 10 Battery.....	14
Connected Features.....	8	Troubleshooting	14
Deleting History.....	8	Resetting the Device.....	14
Data Recording.....	8	Clearing User Data.....	14
Changing the Data Storage Location.....	8	Maximizing Battery Life.....	14
Installing a Memory Card.....	8	Decreasing the Backlight.....	14
Data Management.....	8	Adjusting the Backlight Timeout.....	14
Connecting the Device to Your Computer.....	8	Using the Auto Power Down Feature.....	14
Transferring Files to Your Device.....	9	Calibrating the Touchscreen.....	14
Deleting Files.....	9		
Disconnecting the USB Cable.....	9		

Locking the Touchscreen	14
Unlocking the Touchscreen	14
Getting More Information	14
Temperature Readings	14
Viewing Device Information	14
Updating the Software	14
Appendix	14
Registering Your Device	14
Data Fields	15
Heart Rate Zone Calculations	16
Wheel Size and Circumference	16
Software License Agreement	16
Index	18

Introduction

⚠ WARNING

See the *Important Safety and Product Information* guide in the product box for product warnings and other important information.

Always consult your physician before you begin or modify any exercise program.

Getting Started

When using your device the first time, you should complete these tasks to set up the device and learn about the basic features.

- 1 Charge the device (page 1).
- 2 Install your device using the standard mount (page 1) or the out-front mount (page 1).
- 3 Turn on the device (page 2).
- 4 Locate satellites (page 2).
- 5 Go for a ride (page 3).
- 6 Register the device (page 14).
- 7 Upload your ride to Garmin Connect™ (page 7).

Charging the Device

NOTICE

To prevent corrosion, thoroughly dry the mini-USB port, the weather cap, and the surrounding area before charging or connecting to a computer.

The device is powered by a built-in lithium-ion battery that you can charge using a standard wall outlet or a USB port on your computer.

NOTE: The device will not charge when outside the temperature range of 32° to 113°F (0° to 45°C).

- 1 Pull up the weather cap ① from the mini-USB port ②.



- 2 Plug the small end of the USB cable into the mini-USB port.
 - 3 Plug the USB end of the cable into the AC adapter or a computer USB port.
 - 4 Plug the AC adapter into a standard wall outlet.
- When you connect the device to a power source, the device turns on.
- 5 Charge the device completely.

A fully charged battery can run for up to 15 hours before it must be recharged.

About the Battery

⚠ WARNING

This device contains a lithium-ion battery. See the *Important Safety and Product Information* guide in the product box for product warnings and other important information.

Installing the Standard Mount

For the best GPS reception, position the bike mount so the front of the Edge is oriented toward the sky. You can install the bike mount on the stem or the handlebars.

- 1 Select a secure location to mount the Edge where it does not interfere with the safe operation of your bike.
 - 2 Place the rubber disk ① on the back of the bike mount.
- The rubber tabs align with the back of the bike mount so it stays in place.

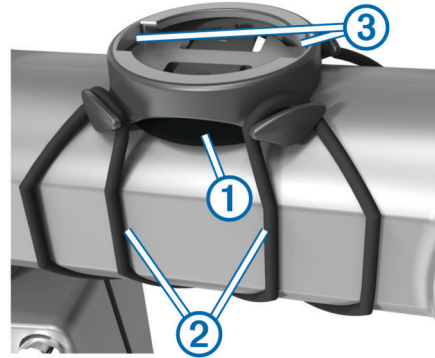

- 3 Place the bike mount on the bike stem.
- 4 Attach the bike mount securely using the two bands ②.
- 5 Align the tabs on the back of the Edge with the bike mount notches ③.
- 6 Press down slightly and turn the Edge clockwise until it locks into place.



Installing the Out-Front Mount

- 1 Select a secure location to mount the Edge where it does not interfere with the safe operation of your bike.
- 2 Use the hex key to remove the screw ① from the handlebar connector ②.

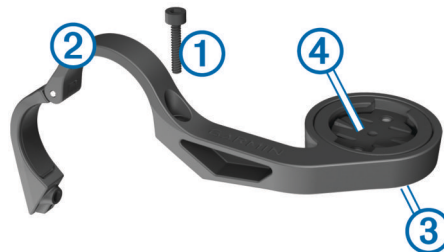

- 3 If you want to change the orientation of the mount, remove the two screws on the back side of the mount ③, rotate the connector ④, and replace the screws.
- 4 If the handlebar diameter is 26 mm, place the rubber pad around the handlebar.
- 5 Place the handlebar connector around the rubber pad or handlebar (31.8 mm diameter).
- 6 Replace the screw.

NOTE: Garmin® recommends a torque specification of 7 lbf-in. (0.8 N-m). Check the tightness of the screw periodically.

- Align the tabs on the back of the Edge with the bike mount notches ⑤.

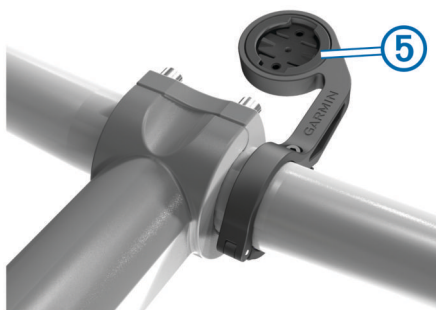

- Press down slightly and turn the Edge clockwise until it locks into place.

Releasing the Edge

- Turn the Edge clockwise to unlock the device.
- Lift the Edge off the mount.

Turning On the Device



The first time you turn on the device, you are prompted to configure system settings and profiles (page 11).

- Hold .
- Follow the on-screen instructions.
- If your device included a heart rate monitor and a GSC™ 10, activate the ANT+™ sensors during configuration.

For more information about ANT+ sensors, see page 5.





Keys













①		Select to turn the backlight on and off. Hold to turn the device on and off.
②		Select to mark a new lap.
③		Select to start and stop the timer.

Home Screen Overview

The home screen gives you quick access to all the features of the Edge.

 Bike 1 >	Select to change your bike profile.
RIDE	Select to go for a ride.
Road >	Select to change your activity profile.
	Select to manage your history, courses, workouts, and personal records.
	Select to view the map.
	Select to view the setup menu.

Using the Touchscreen

- When the timer is running, tap the screen to view the timer overlay.
- The timer overlay allows you to use the settings and search features during a ride.
- Select  to save your changes and close the page.
- Select  to close the page and return to the previous page.
- Select  to return to the previous page.
- Select  to return to the home screen.
- Select  and  to scroll.
- Select  to view the connections page.
- Select  to search for a location.
- Select  to search near a location.
- Select  to search by name.
- Select  to delete an item.

Viewing the Connections Page

The connections page displays the status of the satellite signals, ANT+ sensors, and your smartphone.

From the home screen, select the status bar at the top of the page.

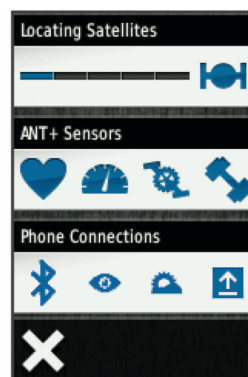

The connections page appears. A flashing icon means the device is searching. You can select any icon to change the settings.

Using the Backlight

- At any time, select anywhere on the screen to turn on the backlight.
- Select  to adjust the backlight brightness and timeout.

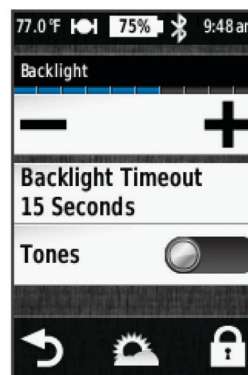

Acquiring Satellite Signals

Before you can use the GPS tracking and navigation features, you must acquire satellite signals.

The device may need a clear view of the sky to acquire satellite signals. The time and date are set automatically based on the GPS position.

- 1 Go outdoors to an open area.
The front of the device should be oriented toward the sky.
- 2 From the home screen, select **RIDE**.
- 3 Wait while the device locates satellites.
It may take 30–60 seconds to locate satellite signals.
TIP: Do not begin moving until the timer page appears (page 3).

Training

Going for a Ride

Before you can record speed and distance, you must locate satellite signals (page 2) or pair your device with an optional ANT+ sensor.

NOTE: History is recorded only while the timer is running.

- 1 From the home screen, select **RIDE**.
- 2 Wait while the device locates satellites.
- 3 Select **▶** to start the timer.

Time 01:08:43	
Speed 18.2 <small>m/h</small>	
Distance 20.23 <small>m</small>	
Elevation 1087 <small>f</small>	Totl. Ascent 1155 <small>f</small>
Cadence 83 <small>r/m</small>	Heart Rate 163 <small>b/m</small>

- 4 Swipe the screen for additional data pages.
- 5 If necessary, tap the screen to view the timer overlay.
- 6 Select **▶** to stop the timer.
- 7 Select **Save**.

Alerts

You can use alerts to train toward specific time, distance, calorie, heart rate, cadence, and power goals. Alert settings are saved with your activity profile.

Setting Range Alerts

If you have an optional heart rate monitor, GSC 10, or power meter, you can set up range alerts. A range alert notifies you any time the device is above or below a specified range of values. For example, you can set the device to alert you when your heart rate is below 60 beats per minute (bpm) and over 210 bpm. You can also use a training zone (page 5) for the range alert.

- 1 From the home screen, select **✖** > **Activity Profiles**.
- 2 Select a profile.
- 3 Select **Alerts**.
- 4 Select **Heart Rate**, **Cadence**, or **Power**.
- 5 Turn on the alert.
- 6 Enter the minimum and maximum values or select a zone.
- 7 Select **✓**.

Each time you exceed or drop below the specified range, a message appears. The device also beeps if audible tones are turned on (page 13).

Setting a Recurring Alert

A recurring alert notifies you every time the device records a specified value or interval. For example, you can set the device to alert you every 30 minutes.

- 1 From the home screen, select **✖** > **Activity Profiles**.
- 2 Select an activity profile.
- 3 Select **Alerts**.
- 4 Select **Time**, **Distance**, or **Calorie**.
- 5 Turn on the alert.
- 6 Enter a value.
- 7 Select **✓**.

Each time you reach the alert value, a message appears. The device also beeps if audible tones are turned on (page 13).

Workouts

You can create custom workouts that include goals for each workout step and for varied distances, times, and calories. You can create workouts using Garmin Connect, and transfer them to your device. You can also create and save a workout directly on your device.

You can schedule workouts using Garmin Connect. You can plan workouts in advance and store them on your device.

Following a Workout From the Web

Before you can download a workout from Garmin Connect, you must have a Garmin Connect account (page 8).

- 1 Connect the device to your computer.
- 2 Go to www.garminconnect.com/workouts.
- 3 Create a new workout.
- 4 Select **Send to Device**.
- 5 Disconnect the device, and turn it on.
- 6 Select **■** > **Workouts**.
- 7 Select the workout.
- 8 Select **Do Workout**.

Creating a Workout

- 1 From the home screen, select **■** > **Workouts** > **+**.
A new workout appears. The first step is open by default, and it can be used as a warmup step.
- 2 Select **Name**, and enter a workout name.
- 3 Select **Add New Step**.
- 4 Select a step, and select **Edit Step**.
- 5 Select **Duration** to specify how the step is measured.
For example, select **Distance** to end the step after a specific distance.
If you select **Open**, you can select **↻** at anytime to end the step.
- 6 If necessary, enter a value in the field below **Duration**.
- 7 Select **Target** to choose your goal during the step.
For example, select **Heart Rate** to maintain a consistent heart rate during the step.
- 8 If necessary, select a target zone or enter a custom range.
For example, you can select a heart rate zone. Each time you exceed or drop below the specified heart rate, the device beeps and displays a message.
- 9 If necessary, select **✓** in the **Rest Lap** field.
During a rest lap, the timer continues to run and data is recorded.
- 10 Select **✓** to save the step.
- 11 Select **➔** to save the workout.

Repeating Workout Steps

Before you can repeat a workout step, you must create a workout with at least one step.

- 1 Select **Add New Step**.
- 2 Select **Duration**.
- 3 Select an option:
 - Select **Repeat** to repeat a step one or more times. For example, you can repeat a 5-mile step ten times.
 - Select **Repeat Until** to repeat a step for a specific duration. For example, you can repeat a 5-mile step for 60 minutes or until your heart rate reaches 160 bpm.
- 4 Select **Back to Step**, and select a step to repeat.
- 5 Select ✓ to save the step.

Starting a Workout

- 1 From the home screen, select ■ > **Workouts**.
- 2 Select a workout.
- 3 Select **Do Workout**.

After you begin a workout, the device displays each step of the workout, the target (if any), and current workout data. An audible alarm sounds when you are about to finish a workout step. A message appears, counting down the time or distance until a new step begins.

Stopping a Workout

- At any time, select ⏪ to end a workout step.
- At any time, select ▶ to stop the timer.
- At any time, select 🏠 > ■ > **Workouts** > **Stop Workout** to end the workout.

Editing a Workout

- 1 From the home screen, select ■ > **Workouts**.
- 2 Select a workout.
- 3 Select ✎.
- 4 Select a step, and select **Edit Step**.
- 5 Change the step attributes, and select ✓.
- 6 Select ↶ to save the workout.

Deleting a Workout

- 1 From the home screen, select ■ > **Workouts**.
- 2 Select a workout.
- 3 Select ✎ > 🗑 > ✓.

Using Virtual Partner®

Your Virtual Partner is a training tool designed to help you meet your goals.

- 1 Go for a ride.
- 2 Scroll to the Virtual Partner page to see who is leading.

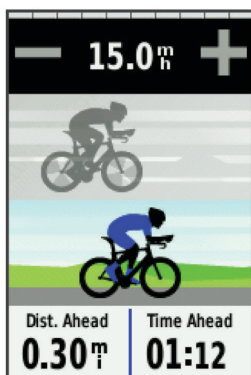

- 3 If necessary, use + and - to adjust the speed of the Virtual Partner during your ride.

Courses

Following a previously recorded activity: You can follow a saved course simply because it is a good route. For example, you can save and follow a bike friendly commute to work.

Racing against a previously recorded activity: You can also follow a saved course, trying to match or exceed previously set performance goals. For example, if the original course was completed in 30 minutes, you can race against a Virtual Partner trying to complete the course in under 30 minutes.

Following an existing ride from Garmin Connect: You can send a course from Garmin Connect to your device. Once it is saved to your device, you can follow the course or race against the course.

Creating a Course on Your Device

Before you can create a course, you must have history with GPS track data saved to your device.

- 1 From the home screen, select ■ > **Courses** > +.
- 2 Select an activity on which to base your course.
- 3 Enter a name for the course.
- 4 Select ✓.
The course appears in the list.
- 5 Select the course, and review the course data.
- 6 If necessary, select **Settings** to edit the course features.
For example, you can change the name of the course or turn on Virtual Partner.
- 7 Select ↶ > **RIDE**.

Following a Course From the Web

Before you can download a course from Garmin Connect, you must have a Garmin Connect account ([page 8](#)).

- 1 Connect the device to your computer.
- 2 Go to www.garminconnect.com.
- 3 Create a new course or select an existing course.
- 4 Select **Send to Device**.
- 5 Disconnect the device, and turn it on.
- 6 Select ■ > **Courses**.
- 7 Select the course.
- 8 Select **RIDE**.

Tips for Training with Courses

- Use turn-by-turn navigation prompts by turning on **Guide Text** ([page 10](#)).
- If you include a warmup, select ▶ to begin the course, and warm up as normal.
- Stay away from your course path as you warm up. When you are ready to begin, head toward your course. When you are on any part of the course path, a message appears.
NOTE: As soon as you select ▶, your Virtual Partner starts the course and does not wait for you to warm up.
- Scroll to the map to view the course map.
If you stray from the course, the device displays a message.

Displaying a Course on the Map

For each course saved to your device, you can customize how it appears on the map. For example, you can set your commute course to always display on the map in yellow. You can have an alternate course display in green. This allows you to see the courses while you are riding, but not follow or navigate a particular course.

- 1 From the home screen, select **■** > **Courses**.
- 2 Select the course.
- 3 Select **Settings** > **Map Display**.
- 4 Select **Always Display** > **On** to have the course appear on the map.
- 5 Select **Color**, and select a color.

The next time you ride near the course, it appears on the map.

Changing the Course Speed

- 1 From the home screen, select **■** > **Courses**.
- 2 Select a course.
- 3 Select **RIDE**.
- 4 Scroll to the Virtual Partner page.
- 5 Use **+** or **-** to adjust the percentage of time to complete the course.

For example, to improve your course time by 20%, enter a course speed of 120%. You will race against the Virtual Partner to finish a 30-minute course in 24 minutes.

Stopping a Course

- 1 Tap the screen to view the timer overlay.
- 2 Select **Q** > **Courses** > **Stop Course**.

Deleting a Course

- 1 From the home screen, select **■** > **Courses**.
- 2 Select a course.
- 3 Select **✕** > **✓**.

Personal Records

When you complete a ride, the device displays any new personal records you achieved during that ride. Personal records include your fastest time over a standard distance, longest ride, and most ascent gained during a ride.

Restoring Your Personal Records

You can revert a personal record back to the previous saved record.

- 1 From the home screen, select **■** > **Personal Records**.
- 2 Select **↶**.
- 3 Select a record, and select **✓**.

NOTE: This does not delete any saved activities.

Training Zones

- Heart rate zones (page 5)
- Power zones (page 7)
- Speed zones (page 5)

Setting Your Speed Zones

Your device contains several different speed zones, ranging from very slow to your maximum speed. The values for the zones are default values and may not match your personal abilities. You can customize your zones on the device or using Garmin Connect.

- 1 From the home screen, **✕** > **Training Zones** > **Speed**.
- 2 Select a zone.
You can enter a custom name for the zone.
- 3 Enter the minimum and maximum speed values.
- 4 Repeat steps 2–3 for each zone.

ANT+ Sensors

Your device can be used with wireless ANT+ sensors. For more information about compatibility and purchasing optional sensors, go to <http://buy.garmin.com>.

Putting On the Heart Rate Monitor

NOTE: If you do not have a heart rate monitor, you can skip this task.

You should wear the heart rate monitor directly on your skin, just below your breastplate. It should be snug enough to stay in place during your activity.

- 1 Snap the heart rate monitor module **①** onto the strap.



The Garmin logos (on the module and the strap) should be right-side up.

- 2 Wet the electrodes **②** on the back of the strap to create a strong connection between your chest and the transmitter.



- 3 If the heart rate monitor has a contact patch **③**, wet the contact patch.
- 4 Wrap the strap around your chest, and connect the strap hook **④** to the loop **⑤**.

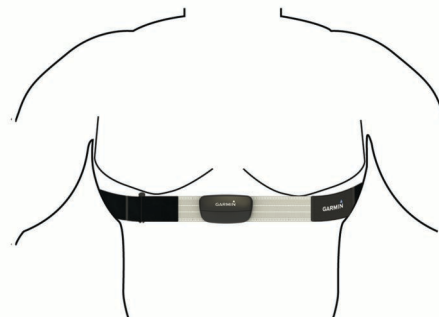

The Garmin logos should be right-side up.

- 5 Bring the device within 10 ft. (3 m) of the heart rate monitor. After you put on the heart rate monitor, it is active and sending data.

Setting Your Heart Rate Zones

The device uses your user profile information from the initial setup to determine your heart rate zones. You can manually adjust the heart rate zones according to your fitness goals (page 6). For the most accurate calorie data during your activity, set your maximum heart rate, minimum heart rate, resting heart rate, and heart rate zones.

- 1 From the home screen, select **✕** > **Training Zones** > **Heart Rate**.
- 2 Enter your maximum, minimum, and resting heart rate values.
The zone values update automatically, but you can also edit each value manually.
- 3 Select **Based On:**.

4 Select an option:

- Select **BPM** to view and edit the zones in beats per minute.
- Select **% Max.** to view and edit the zones as a percentage of your maximum heart rate.
- Select **% HRR** to view and edit the zones as a percentage of your resting heart rate.

About Heart Rate Zones

Many athletes use heart rate zones to measure and increase their cardiovascular strength and improve their level of fitness. A heart rate zone is a set range of heartbeats per minute. The five commonly accepted heart rate zones are numbered from 1 to 5 according to increasing intensity. Generally, heart rate zones are calculated based on percentages of your maximum heart rate.

Fitness Goals

Knowing your heart rate zones can help you measure and improve your fitness by understanding and applying these principles.

- Your heart rate is a good measure of exercise intensity.
- Training in certain heart rate zones can help you improve cardiovascular capacity and strength.
- Knowing your heart rate zones can prevent you from overtraining and can decrease your risk of injury.

If you know your maximum heart rate, you can use the table (page 16) to determine the best heart rate zone for your fitness objectives.

If you do not know your maximum heart rate, use one of the calculators available on the Internet. Some gyms and health centers can provide a test that measures maximum heart rate.

Installing the GSC 10

NOTE: If you do not have a GSC 10, you can skip this task.

Both magnets must be aligned with their respective indication lines for the Edge to receive data.

- 1 Place the GSC 10 on the rear chain stay (on the side opposite the drive train).
- 2 If necessary, place the flat rubber pad ① or the triangle-shaped rubber pad between the GSC 10 and the chain stay for stability.

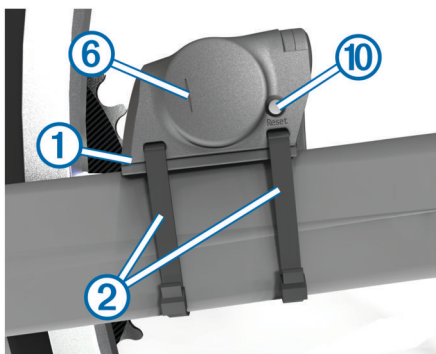

- 3 Loosely attach the GSC 10 using two cable ties ②.
- 4 Attach the pedal magnet ③ to the crank arm using the adhesive mount and a cable tie ④.

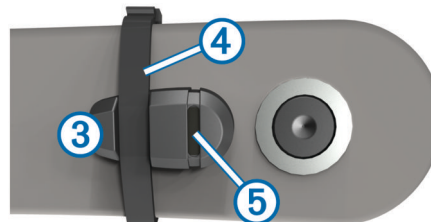

The pedal magnet must be within 5 mm of the GSC 10. The indication line ⑤ on the pedal magnet must line up with the indication line ⑥ on the GSC 10.

- 5 Unscrew the spoke magnet ⑦ from the plastic piece.

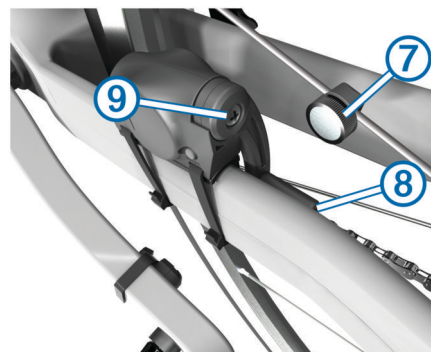

- 6 Place the spoke in the groove of the plastic piece, and tighten it slightly.

The spoke magnet can face away from the GSC 10 if there is not enough room between the sensor arm and the spoke. The spoke magnet must line up with the indication line ⑧ on the sensor arm.

- 7 Loosen the screw ⑨ on the sensor arm.
- 8 Move the sensor arm to within 5 mm of the spoke magnet. You can also tilt the GSC 10 closer to either magnet to improve alignment.
- 9 Select **Reset** ⑩ on the GSC 10. The LED turns red, then green.
- 10 Pedal to test the sensor alignment. The red LED blinks each time the pedal magnet passes the sensor. The green LED blinks each time the spoke magnet passes the sensor arm.
NOTE: The LED blinks for the first 60 passes after a reset. Select **Reset** again if you require additional passes.
- 11 When everything is aligned and working correctly, tighten the cable ties, the sensor arm, and the spoke magnet. Garmin recommends that the torque is 1.9 to 2.4 lbf-in. (0.21 to 0.27 N-m) to ensure a water tight seal on the GSC 10 sensor arm.

About the GSC 10

Cadence data from the GSC 10 is always recorded. If there is no GSC 10 paired, GPS data is used to calculate the speed and distance.

Cadence is your rate of pedaling or “spinning” measured by the number of revolutions of the crank arm per minute (rpm). There are two sensors on the GSC 10: one for cadence and one for speed.

Data Averaging for Cadence or Power

The non-zero data-averaging setting is available if you are training with an optional cadence sensor or power meter. The default setting is to exclude zero values that occur when you are not pedaling.

To change this setting, see [page 12](#).

Training with Power Meters

- Go to www.garmin.com/intosports for a list of third-party ANT+ sensors that are compatible with your device.
- For more information, see the owner's manual for your power meter.
- Adjust your power zones to match your goals and abilities (page 7).
- Use range alerts to be notified when you reach a specified power zone (page 3).
- Customize the power data fields (page 11).

Setting Your Power Zones

The values for the zones are default values and may not match your personal abilities. You can manually adjust your zones on the device or using Garmin Connect. If you know your functional threshold power (FTP) value, you can enter it and allow the software to calculate your power zones automatically.

- 1 From the home screen, select **⚙** > **Training Zones** > **Power**.
- 2 Enter your FTP value.
- 3 Select **Based On**:
- 4 Select an option:
 - Select **Watts** to view and edit the zones in watts.
 - Select **% FTP** to view and edit the zones as a percentage of your functional threshold power.

Calibrating Your Power Meter

Before you can calibrate your power meter, it must be properly installed, paired with your GPS device, and actively recording data.

For calibration instructions specific to your power meter, refer to the manufacturer's instructions.

- 1 From the home screen, select **⚙**.
- 2 Select **Bike Profiles**.
- 3 Select a profile.
- 4 Select **⚙** > **Calibrate**.
- 5 Keep your power meter active by pedaling until the message appears.
- 6 Follow the on-screen instructions.

Pairing Your ANT+ Sensors

Before you can pair, you must put on the heart rate monitor or install the sensor.

Pairing is the connecting of ANT+ wireless sensors, for example, connecting a heart rate monitor with your Garmin device.

- 1 Bring the device within range (3 m) of the sensor.
NOTE: Stay 10 m away from other ANT+ sensors while pairing.
- 2 From the home screen, select **⚙** > **Bike Profiles**
- 3 Select a profile.
- 4 Select a sensor.
- 5 Enable the sensor, and select **Search**.

When the sensor is paired with your device, the sensor status is **Connected**. You can customize a data field to display sensor data.

Pairing a Heart Rate Monitor

Before you can pair, you must put on the heart rate monitor.

- 1 Bring the device within range (3 m) of the heart rate monitor.
NOTE: Stay 10 m away from other ANT+ sensors while pairing.

- 2 Select **⚙** > **Heart Rate** > **Enable** > **Search**.

When the heart rate monitor is paired with your device, the sensor status is **Connected**.

Using the Weight Scale

If you have an ANT+ compatible weight scale, the device can read the data from the weight scale.

- 1 From the home screen, select **⚙** > **Weight Scale**.

A message appears when the weight scale is found.

- 2 Stand on the scale when indicated.

NOTE: If using a body composition scale, remove shoes and socks to ensure that all body composition parameters are read and recorded.

- 3 Step off the scale when indicated.

TIP: If an error occurs, step off the scale. Step on when indicated.

History

History includes time, distance, calories, speed, lap data, elevation, and optional ANT+ sensor information.

NOTE: History is not recorded while the timer is stopped or paused.

When the device memory is full, a message appears. The device does not automatically delete or overwrite your history. Upload your history to Garmin Connect periodically to keep track of all your ride data.

Viewing Your Ride

- 1 From the home screen, select **📅** > **Rides**.
- 2 Select **Last Ride** or **All Rides**.
- 3 Select an option.

Viewing Data Totals

You can view the accumulated data you have saved to the Edge, including the number of rides, time, distance, and calories.

From the home screen, select **📅** > **Totals**.

Sending Your Ride to Garmin Connect

NOTICE

To prevent corrosion, thoroughly dry the mini-USB port, the weather cap, and the surrounding area before charging or connecting to a computer.

- 1 Pull up the weather cap ① from the mini-USB port ②.



- 2 Plug the small end of the USB cable into the mini-USB port.
- 3 Plug the large end of the USB cable into a computer USB port.
- 4 Go to www.garminconnect.com.

- 5 Select **Getting Started**.
- 6 Follow the on-screen instructions.

Garmin Connect

Connect with your friends on Garmin Connect. Garmin Connect gives you the tools to track, analyze, share, and encourage each other. Record the events of your active lifestyle including runs, walks, rides, swims, hikes, triathlons, and more. To sign up for a free account, go to www.garminconnect.com/start.

Store your activities: After you complete and save an activity with your device, you can upload that activity to Garmin Connect and keep it as long as you want.

Analyze your data: You can view more detailed information about your activity, including time, distance, elevation, heart rate, calories burned, an overhead map view, pace and speed charts, and customizable reports.

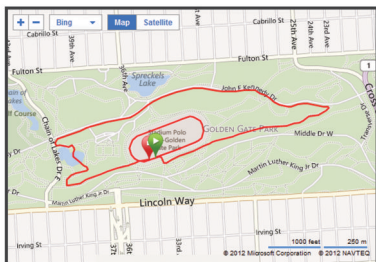

Plan your training: You can choose a fitness goal and load one of the day-by-day training plans.

Share your activities: You can connect with friends to follow each other's activities or post links to your activities on your favorite social networking sites.

Connected Features

The Edge has several connected features for your compatible Bluetooth® enabled smartphone. For more information about how to use your Edge, go to www.garmin.com/intosports/apps.

NOTE: Your Edge must be connected to your Bluetooth enabled smartphone to take advantage of these features.

LiveTrack: Allows friends and family to follow your races and training activities in real time. You can invite followers using email or social media, allowing them to view your live data on a Garmin Connect tracking page.

Activity upload to Garmin Connect: Automatically sends your activity to Garmin Connect as soon as you finish recording the activity.

Course and workout downloads from Garmin Connect: Allows you to search for activities on Garmin Connect using your smartphone and send them to your device so you can repeat them as a course or workout.

Social media interactions: Allows you to post an update to your favorite social media website when you upload an activity to Garmin Connect.

Weather updates: Sends real-time weather conditions and alerts to your device.

Deleting History

- 1 From the home screen, select **■** > **Delete**.
- 2 Select an option:
 - Select **All Rides** to delete all saved activities from the history.
 - Select **Old Rides** to delete activities recorded more than one month ago.
 - Select **All Totals** to reset all distance and time totals.

NOTE: This does not delete any saved activities.

- Select **All Courses** to delete all courses you have saved or transferred to the device.
- Select **All Workouts** to delete all workouts you have saved or transferred to the device.
- Select **All Personal Records** to delete all personal records saved to the device.

NOTE: This does not delete any saved activities.

- 3 Select **✓**.

Data Recording

The device uses smart recording. It records key points where you change direction, speed, or heart rate.

When a power meter is paired, the device records points every second. Recording points every second provides an extremely detailed track, and uses more of the available memory.

For information about data averaging for cadence and power, see [page 6](#).

Changing the Data Storage Location

- 1 From the home screen, select **✕** > **System** > **Data Recording** > **Record To**.
- 2 Select an option:
 - Select **Internal Storage** to save your data to the device memory.
 - Select **Memory Card** to save your data to an optional memory card.

Installing a Memory Card

You can install a microSD™ memory card for additional storage or pre-loaded maps.

- 1 Pull up the weather cap **①** from the microSD card slot **②**.



- 2 Press in the card until it clicks.

Data Management

NOTE: The device is not compatible with Windows® 95, 98, Me, Windows NT®, and Mac® OS 10.3 and earlier.

Connecting the Device to Your Computer

NOTICE

To prevent corrosion, thoroughly dry the mini-USB port, the weather cap, and the surrounding area before charging or connecting to a computer.

- 1 Pull up the weather cap from the mini-USB port.
- 2 Plug the small end of the USB cable into the mini-USB port.
- 3 Plug the large end of the USB cable into a computer USB port.

Your device and memory card (optional) appear as removable drives in My Computer on Windows computers and as mounted volumes on Mac computers.

Transferring Files to Your Device

- 1 Connect the device to your computer ([page 8](#)).

Your device and memory card (optional) appear as removable drives in My Computer on Windows computers and as mounted volumes on Mac computers.

NOTE: Some computers with multiple network drives cannot display device drives. See your operating system help file to learn how to map the drive.

- 2 On your computer, open the file browser.
- 3 Select a file.
- 4 Select **Edit > Copy**.
- 5 Open the **Garmin** or memory card drive or volume.
- 6 Select **Edit > Paste**.

The file appears in the list of files in the device memory or on the memory card.

Deleting Files

NOTICE

If you do not know the purpose of a file, do not delete it. Your device memory contains important system files that should not be deleted.

- 1 Open the **Garmin** drive or volume.
- 2 If necessary, open a folder or volume.
- 3 Select a file.
- 4 Press the **Delete** key on your keyboard.

Disconnecting the USB Cable

If your device is connected to your computer as a removable drive or volume, you must safely disconnect your device from your computer to avoid data loss. If your device is connected to your Windows computer as a portable device, it is not necessary to safely disconnect.

- 1 Complete an action:
 - For Windows computers, select the **Safely Remove Hardware** icon in the system tray, and select your device.
 - For Mac computers, drag the volume icon to the trash.
- 2 Disconnect the cable from your computer.

Navigation

This section describes navigation features and settings. Navigation settings also apply to navigating courses ([page 4](#)).

- Locations and finding places ([page 9](#))
- Route settings ([page 10](#))
- Optional maps ([page 10](#))
- Map settings ([page 10](#))

Locations

You can record and store locations in the device.

Saving Your Location

You can save your present location, such as your home or parking spot.

From the home screen, select **✂ > System > GPS > Mark Location > ✓**.

Saving Locations from the Map

- 1 From the home screen, select **📍 > 📍**.
- 2 Browse the map for the location.
- 3 Select the location on the map.
Location information appears at the top of the map.
- 4 Select the information bar at the top of the screen.

- 5 Select **▶ > ✓** to save the location.

Navigating to a Location

- 1 From the home screen, select **📍 > 📍**.
- 2 Select an option:
 - Select **Locations** to navigate to a saved location.
 - Select **Recent Finds** to navigate to one of the last 50 locations you have found.
 - Select **Coordinates** to navigate to known coordinates.
 - Select **All POIs** (requires routable maps) to navigate to a point of interest.
 - Select **Addresses** (requires routable maps) to navigate to a specific address.
 - Select **Intersections** to navigate to the intersection of two streets.
 - Select **Cities** to navigate to a city.
 - Select **📍** to narrow your search.
- 3 If necessary, select **📄** to enter specific search information (optional for locations, POIs, and cities only).
- 4 Select a location.
- 5 Select **RIDE**.
- 6 Follow the on-screen instructions to your destination.

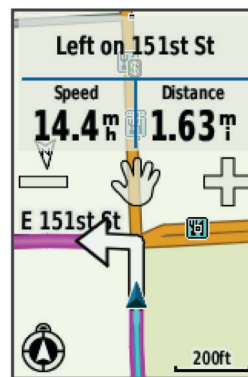

Navigating to Known Coordinates

- 1 From the home screen, select **📍 > 📍 > Coordinates**.
- 2 Enter the coordinates, and select **✓**.
- 3 Follow the on-screen directions to your destination.

Navigating Back to Start

At any point during your ride, you can return to the starting point.

- 1 Go for a ride ([page 3](#)).
- 2 During your ride, tap the screen to view the timer overlay.
- 3 Select **📍 > Back to Start > RIDE**.

The device navigates you back to the starting point of your ride.

Stopping Navigation

- 1 Tap the screen to view the timer overlay.
- 2 Select **📍 > Where To > Stop Navigation**.

Projecting a Location

You can create a new location by projecting the distance and bearing from a marked location to a new location.

- 1 From the home screen, select **📍 > 📍 > Locations**.
- 2 Select a location.
- 3 Select the information bar at the top of the screen.
- 4 Select **📏 > Project Waypoint**.
- 5 Enter the bearing and distance to the projected location.

- 6 Select ✓.

Editing Locations

- 1 From the home screen, select > **Q** > **Locations**.
- 2 Select a location.
- 3 Select the information bar at the top of the screen.
- 4 Select .
- 5 Select an attribute.

For example, select **Change Elevation** to enter a known altitude for the location.

- 6 Enter the new information, and select ✓.

Deleting Locations

- 1 From the home screen, select > **Q** > **Locations**.
- 2 Select a location.
- 3 Select the information bar at the top of the screen.
- 4 Select > **Delete Waypoint** > ✓.

Route Settings

Select > **Activity Profiles**, select a profile, and select **Navigation** > **Routing**.

Activity: Allows you to select an activity for the device to calculate your route (page 10).

Calculation Method: Allows you to select the calculation method to optimize your route.

Lock On Road (requires routable maps): Locks the position icon, which represents your position on the map, onto the nearest road.

Avoidance Setup (requires routable maps): Allows you to select the road type you want to avoid.

Recalculation (requires routable maps): Allows you to select the recalculation method when you deviate from the route.

Selecting an Activity for Route Calculation

You can set the device to calculate the route based on activity type.

- 1 Select > **Activity Profiles**.
- 2 Select a profile.
- 3 Select **Navigation** > **Routing** > **Activity**.
- 4 Select an option to calculate your route.
For example, **Tour Cycling** or **Mountain Biking**.

Purchasing Additional Maps

Before purchasing additional maps, you should determine the version of the maps that are loaded on your device.

- 1 From the home screen, select > **Activity Profiles**.
- 2 Select a profile.
- 3 Select **Navigation** > **Map** > **Map Information**.
- 4 Select a map.
- 5 Select .
- 6 Go to <http://buy.garmin.com>, or contact your Garmin dealer.

Finding an Address

You can use optional City Navigator® maps to search for addresses, cities, and other locations. The detailed and routable maps contain millions of points of interest, such as restaurants, hotels, and auto services.

- 1 From the home screen, select > **Q** > **Addresses**.
- 2 Follow the on-screen instructions.
TIP: If you are unsure of the city, select **Search All**.
- 3 Select the address, and select **RIDE**.

Finding a Point of Interest

- 1 From the home screen, select > **Q**.
- 2 Select a category.
TIP: If you know the name of the business, select **All POIs** > to enter the name.
- 3 If necessary, select a subcategory.
- 4 Select the location, and select **RIDE**.

Finding Nearby Locations

- 1 From the home screen, select > **Q** > .
- 2 Select an option.
For example, select **A Recent Find** to search for a restaurant near the address you recently searched for.
- 3 If necessary, select a category and subcategory.
- 4 Select the location, and select **RIDE**.

Topographical Maps

Your device may include topographical maps or you can purchase them from <http://buy.garmin.com>. Garmin recommends that you download BaseCamp™ to plan your routes and activities using topographical maps.

Map Settings

Select > **Activity Profiles**, select a profile, and select **Navigation** > **Map**.

Orientation: Adjusts how the map is shown on the page (page 10).

Auto Zoom: Automatically selects the appropriate zoom level for optimal use on your map. When **Off** is selected, you must zoom in or out manually.

Guide Text: Sets when the turn-by-turn navigation prompts are shown.

Map Visibility: Allows you to set advanced map features (page 10).

Map Information: Enables or disables the maps currently loaded on the device.

Advanced Map Settings

Select > **Activity Profiles**, select a profile, and select **Navigation** > **Map** > **Map Visibility**.

Map Visibility Mode: **Auto** and **High Contrast** have preset values. You can choose **Custom** to set each value.

Zoom Levels: Sets map items to draw or appear at or below the selected zoom level.

Text Size: Sets the text size for map items.

Detail: Sets the amount of detail shown on the map. Showing more detail may cause the map to redraw more slowly.

Shaded Relief: Shows detail relief on the map (if available) or turns off shading.

Changing the Map Orientation

- 1 Select > **Activity Profiles**.
- 2 Select a profile.
- 3 Select **Navigation** > **Map** > **Orientation**.
- 4 Select an option:
 - Select **North Up** to show north at the top of the page.
 - Select **Track Up** to show your current direction of travel at the top of the page.
 - Select **Automobile Driving** to show an automotive perspective with the direction of travel at the top.

Customizing Your Device

Profiles

The Edge has several ways for you to customize the device including profiles. Profiles are a collection of settings that optimize your device based on how you are using it. For example, you can create different settings and views for training and mountain biking.

When you are using a profile and you change settings such as data fields or units of measurement, the changes are saved automatically as part of the profile.

Bike Profiles: You can create bike profiles for each bike you own. The bike profile includes optional ANT+ sensors, bike weight, wheel size, odometer value, and crank length.

Activity Profiles: You can create activity profiles for each type of biking. For example, you can have a profile for training, racing, and mountain biking. The activity profile includes customized data pages, alerts, training zones (such as heart rate and speed), training settings (such as **Auto Pause** and **Auto Lap**), and navigation settings.

User Profile: You can update your gender, age, weight, height, and lifetime athlete settings. The device uses this information to calculate accurate ride data.

Updating Your Bike Profile

You can customize 10 bike profiles. The device uses the bike weight, odometer value, wheel size, and crank length to calculate accurate ride data.

- 1 From the home screen, select **⌘** > **Bike Profiles**.
- 2 Select an option:
 - Select a profile.
 - Select **+** to add a new profile.
- 3 Select the name of the bike.
- 4 If necessary, edit the name, color, and image for the profile.
- 5 If you are using a speed and cadence sensor or power sensor, select an option:
 - Select **Wheel Size** > **Automatic** to calculate your wheel size using GPS distance.
 - Select **Wheel Size** > **Custom** to enter your wheel size. For a table of wheel sizes and circumferences, see [page 16](#).
 - Select **Crank Length** > **Automatic** to calculate your crank length using GPS distance.
 - Select **Crank Length** > **Custom** to enter your crank length.

Any changes you make are saved to the active profile.

Updating Your Activity Profile

You can customize five activity profiles. You can customize your settings and data fields for a particular activity or trip.

- 1 From the home screen, select **⌘** > **Activity Profiles**.
- 2 Select an option:
 - Select a profile.
 - Select **+** to add a new profile.
- 3 If necessary, edit the name and background image for the profile.
- 4 Select an option:
 - Select **Training Pages** to customize the data pages and data fields ([page 11](#)).
 - Select **Alerts** to customize your training alerts ([page 3](#)).
 - Select **Auto Pause** to change when the timer automatically pauses ([page 11](#)).

- Select **Auto Lap** to set how laps are triggered ([page 12](#)).
- Select **Auto Scroll** to customize the display of the training data pages when the timer is running ([page 12](#)).
- Select **Navigation** to customize your map ([page 10](#)) and route ([page 10](#)) settings.

Any changes you make are saved to the active profile.

Setting Up Your User Profile

You can update your gender, age, weight, height, and lifetime athlete settings. The device uses this information to calculate accurate ride data.

- 1 From the home screen, select **⌘** > **User Profile**.
- 2 Select an option.

About Lifetime Athletes

A lifetime athlete is an individual who has trained intensely for many years (with the exception of minor injuries) and has a resting heart rate of 60 beats per minute (bpm) or less.

Bluetooth Settings

Select **⌘** > **Bluetooth**.

Enable: Enables Bluetooth wireless technology.

NOTE: Other Bluetooth settings appear only when Bluetooth is enabled.

Friendly Name: Allows you to enter a friendly name that identifies your devices with Bluetooth wireless technology.

Pair Smartphone: Connects your device with a compatible Bluetooth-enabled smartphone.

About Training Settings

The following options and settings allow you to customize your device based on your training needs. These settings are saved to an activity profile. For example, you can set time alerts for your racing profile and you can set an Auto Lap[®] position trigger for your mountain biking profile.

Customizing the Data Pages

You can customize data pages for each activity profile ([page 11](#)).

- 1 From the home screen, select **⌘** > **Activity Profiles**.
- 2 Select a profile.
- 3 Select **Training Pages**.
- 4 Select a data page.
- 5 If necessary, enable the data page.
- 6 Select the number of data fields you want to see on the page.
- 7 Select **✓**.
- 8 Select a data field to change it.
- 9 Select **✓**.

Using Auto Pause

You can use Auto Pause[®] to pause the timer automatically when you stop moving or when your speed drops below a specified value. This feature is helpful if your ride includes stop lights or other places where you need to slow down or stop.





NOTE: History is not recorded while the timer is stopped or paused.

- 1 From the home screen, select **⌘** > **Activity Profiles**.
- 2 Select a profile.
- 3 Select **Auto Pause** > **Auto Pause Mode**.
- 4 Select an option:
 - Select **When Stopped** to pause the timer automatically when you stop moving.

- Select **Custom Speed** to pause the timer automatically when your speed drops below a specified value.
- 5 If necessary, customize optional time data fields ([page 11](#)).
The **Time - Elapsed** data field displays the entire time including paused time.

Marking Laps by Position

You can use Auto Lap to automatically mark the lap at a specific position. This feature is helpful for comparing your performance over different parts of a ride (for example, a long climb or training sprints). During courses, use the **By Position** option to trigger laps at all of the lap positions saved in the course.

- 1 From the home screen, select **✖ > Activity Profiles**.
- 2 Select a profile.
- 3 Select **Auto Lap > Auto Lap Trigger > By Position > Lap At**.
- 4 Select an option:
 - Select **Lap Press Only** to trigger the lap counter each time you select  and each time you pass any of those locations again.
 - Select **Start and Lap** to trigger the lap counter at the GPS location where you select  and at any location during the ride where you select .
 - Select **Mark and Lap** to trigger the lap counter at a specific GPS location marked before the ride and at any location during the ride where you select .
- 5 If necessary, customize the lap data fields ([page 11](#)).

Marking Laps by Distance

You can use Auto Lap to automatically mark the lap at a specific distance. This feature is helpful for comparing your performance over different parts of a ride (for example, every 10 miles or 40 kilometers).

- 1 From the home screen, select **✖ > Activity Profiles**.
- 2 Select a profile.
- 3 Select **Auto Lap > Auto Lap Trigger > By Distance > Lap At**.
- 4 Enter a value.
- 5 If necessary, customize the lap data fields ([page 11](#)).

Using Auto Scroll

You can use the auto scroll feature to automatically cycle through all of the training data pages while the timer is running.

- 1 From the home screen, select **✖ > Activity Profiles**.
- 2 Select a profile.
- 3 Select **Auto Scroll > Auto Scroll Speed**.
- 4 Select a display speed.

Changing the Start Notice

This feature automatically detects when your device has acquired satellites and is moving. It is a reminder to start the timer so you can record your ride data.

- 1 From the home screen, select **✖ > Activity Profiles**.
- 2 Select a profile.
- 3 Select **Start Notice > Start Notice Mode**.
- 4 Select an option:
 - Select **Once**.
 - Select **Repeat > Repeat Delay** to change the amount of time to delay the reminder.

System Settings

Select **✖ > System**.

- GPS Settings ([page 12](#))

- Display Settings ([page 12](#))
- Data Recording Settings ([page 12](#))
- Unit Settings ([page 12](#))
- Configuration Settings ([page 13](#))
- Language Settings ([page 13](#))
- Tone Settings ([page 13](#))

GPS Settings

Training Indoors

You can turn GPS off when you are training indoors or to save battery life.

From the home screen, select **✖ > System > GPS > GPS Mode > Off**.

When GPS is off, speed and distance are not available unless you have an optional sensor that sends speed and distance data to the device (such as the GSC 10). The next time you turn on the device, it will search for satellite signals again.

Setting Your Elevation

If you have accurate elevation data for your present location, you can manually calibrate the altimeter on your device.

- 1 From the home screen, select **✖ > System > GPS > Set Elevation**.
- 2 Enter the elevation, and select **✓**.

Viewing Satellites

The satellite page shows your current GPS satellite information. For more information about GPS, go to www.garmin.com/aboutGPS.

From the home screen, select **✖ > System > GPS > View Satellites**.

GPS accuracy appears at the bottom of the page. The green bars represent the strength of each satellite signal received (the number of the satellite appears below each bar).

Display Settings

Select **✖ > System > Display**.

Backlight Timeout: Adjusts the length of time before the backlight turns off ([page 2](#)).

Color Mode: Sets the device to display day or night colors. You can select **Auto** to allow the device to automatically set day or night colors based on the time of day.

Screen Capture: Allows you to save the image on the device screen.

Calibrate Screen: Aligns the screen to properly respond to touches ([page 14](#)).

Data Recording Settings

Select **✖ > System > Data Recording**.

Record To: Sets the data storage location ([page 8](#)).

Recording Interval: Controls how the device records activity data. **Smart** records key points where you change direction, speed, or heart rate. **1 Sec.** records points every second. It creates a very detailed record of your activity and increases the size of the activity.

Data Averaging: Controls whether the device includes zero values for cadence and power data that occur when you are not pedaling ([page 6](#)).

Changing the Units of Measure

You can customize units of measure for distance and speed, elevation, temperature, weight, position format, and time format.

- 1 Select **✖ > System > Units**.
- 2 Select a measurement type.
- 3 Select a unit of measure for the setting.

Changing the Configuration Settings

You can modify all of the settings you configured in the initial setup.

- 1 Select **✖** > **System** > **Device Reset** > **Initial Setup**.
- 2 Follow the on-screen instructions.

Changing the Device Language

From the home screen, select **✖** > **System** > **Language**.

Setting the Device Tones

From the home screen, select **✖** > **System** > **Tones**.

Time Zones

Each time you turn on the device and acquire satellites, the device automatically detects your time zone and the current time of day.

Device Information

Specifications

Edge Specifications

Battery type	1100 mAh rechargeable, built-in lithium-ion battery
Battery life	15 hours, typical usage
Optional external battery (accessory)	20 hours, typical usage
Water resistance	IPX7
Operating temperature range	From -4° to 140°F (from -20° to 60°C)
Charging temperature range	From 32° to 113°F (from 0° to 45°C)
Bands (O-rings) for the standard mount	Two sizes: <ul style="list-style-type: none">• 1.3 × 1.5 × 0.9 in. AS568-125• 1.7 × 1.9 × 0.9 in. AS568-131 NOTE: Use Ethylene Propylene Diene Monomer (EPDM) replacement bands only. Go to http://buy.garmin.com , or contact your Garmin dealer.

About IPX7

NOTICE

The device is water resistant to IEC Standard 60529 IPX7. It can withstand immersion in 1 meter of water for 30 minutes. Prolonged submersion can cause damage to the device. After submersion, be certain to wipe dry and air dry the device before using or charging.

Heart Rate Monitor Specifications

Battery type	User-replaceable CR2032, 3 volts
Battery life	Up to 4.5 years (1 hour per day). When the battery is low, a message appears on your compatible Garmin device.
Water resistance	Water resistant to 98.4 ft. (30 m) NOTE: This product does not transmit heart rate data while swimming.
Operating temperature range	From 23° to 122°F (from -5° to 50°C)
Radio frequency/protocol	2.4 GHz ANT+ wireless communications protocol

GSC 10 Specifications

Battery type	User-replaceable CR2032, 3 volts
Battery life	Approximately 1.4 years (1 hour per day)
Water resistance	IPX7

Operating temperature range	From 5° to 158°F (from -15° to 70°C)
Radio frequency/protocol	2.4 GHz ANT+ wireless communications protocol

Device Care

NOTICE

Do not store the device where prolonged exposure to extreme temperatures can occur, because it can cause permanent damage.

Never use a hard or sharp object to operate the touch screen, or damage may result.

Avoid chemical cleaners and solvents that can damage plastic components.

Secure the weather cap tightly to prevent damage to the mini-USB port.

Cleaning the Device

- 1 Wipe the device with a cloth dampened with a mild detergent solution.
- 2 Wipe it dry.

Caring for the Heart Rate Monitor

NOTICE

You must unsnap the module before cleaning the strap.

A build up of sweat and salt on the strap can decrease the ability of the heart rate monitor to report accurate data.

- Go to www.garmin.com/HRMcare for detailed washing instructions.
- Rinse the strap after every use.
- Machine wash the strap after every seven uses.
- Do not put the strap in a dryer.
- To prolong the life of your heart rate monitor, unsnap the module when not in use.

Heart Rate Monitor Battery

⚠ WARNING

Do not use a sharp object to remove user-replaceable batteries.

Contact your local waste disposal department to properly recycle the batteries. Perchlorate Material – special handling may apply. Go to www.dtsc.ca.gov/hazardouswaste/perchlorate.

Replacing the Heart Rate Monitor Battery

- 1 Use a small Phillips screwdriver to remove the four screws on the back of the module.
- 2 Remove the cover and battery.



- 3 Wait 30 seconds.
- 4 Insert the new battery with the positive side facing up.
NOTE: Do not damage or lose the O-ring gasket.
- 5 Replace the back cover and the four screws.

After you replace the heart rate monitor battery, you must pair it with the device again.

Replacing the GSC 10 Battery

- 1 Locate the circular battery cover ① on the side of the GSC 10.



- 2 Use a coin to twist the cover counter-clockwise until it is loose enough to remove (the arrow points to unlocked).
- 3 Remove the cover and the battery ②.
- 4 Wait 30 seconds.
- 5 Insert the new battery with the positive side facing up.
NOTE: Do not damage or lose the O-ring gasket.
- 6 Use a coin to twist the cover clockwise back into place (the arrow points to locked).

After you replace the GSC 10 battery, you must pair the GSC 10 with the device again.

Troubleshooting

Resetting the Device

If the device stops responding, you may need to reset it. This does not erase any of your data or settings.

- 1 Hold \odot for 10 seconds.
- 2 Hold \odot for one second to turn on the device.

Clearing User Data

You can restore all of the device settings to the factory default values.

NOTE: This deletes all user-entered information, but it does not delete your history.

- 1 Turn off the device.
- 2 Place your finger on the top left corner of the touchscreen.
- 3 While holding your finger on the touchscreen, turn on the device.
- 4 Select \checkmark .

Maximizing Battery Life

- Decrease the backlight ([page 14](#)).
- Shorten the backlight timeout ([page 14](#)).
- Select the **Smart** recording interval ([page 12](#)).
- Turn on the **Auto Power Down** feature ([page 14](#)).
- Turn off the Bluetooth wireless feature ([page 11](#)).

Decreasing the Backlight

- 1 Select \odot to open the status page.
- 2 Use $-$ and $+$ to adjust the brightness.

Adjusting the Backlight Timeout

You can decrease the backlight timeout to maximize the battery life.

- 1 Select \odot > **Backlight Timeout**.
- 2 Select an option.

Using the Auto Power Down Feature

This feature automatically turns off the device after 15 minutes of inactivity.

- 1 Select \times > **System** > **Auto Power Down**.
- 2 Select **On**.

Calibrating the Touchscreen

- 1 From the home screen, select \times > **System** > **Display** > **Calibrate Screen**.
- 2 Follow the on-screen instructions.

Locking the Touchscreen

You can lock the screen to prevent inadvertent screen touches.

- 1 Select \odot .
- 2 Select \mathfrak{A} .

Unlocking the Touchscreen

- 1 Select \odot .
- 2 Select \mathfrak{A} .

Getting More Information

You can find more information about this product on the Garmin website.

- Go to www.garmin.com/intosports.
- Go to www.garmin.com/learningcenter.
- Go to <http://buy.garmin.com>, or contact your Garmin dealer for information about optional accessories and replacement parts.

Temperature Readings

The device may display temperature readings that are higher than the actual air temperature if the device is placed in direct sunlight, held in your hand, or is charging with an external battery pack. Also, the device will take some time to adjust to significant changes in temperature.

Viewing Device Information

You can view the unit ID, software version, and license agreement.

From the home screen, select \times > **System** > **About**.

Updating the Software

NOTE: Updating the software does not erase any of your data or settings.

- 1 Connect your device to a computer using the USB cable.
- 2 Go to www.garmin.com/products/webupdater.
- 3 Follow the on-screen instructions.

Appendix

Registering Your Device

Help us better support you by completing our online registration today.

- Go to <http://my.garmin.com>.
- Keep the original sales receipt, or a photocopy, in a safe place.

Data Fields

Some data fields require ANT+ accessories to display data.

Balance: The current left/right power balance.

Balance - 10s Avg.: The 10-second moving average of the left/right power balance.

Balance - 30s Avg.: The 30-second moving average of the left/right power balance.

Balance - 3s Avg.: The three-second moving average of the left/right power balance.

Balance - Avg.: The average left/right power balance for the current activity.

Balance - Lap: The average left/right power balance for the current lap.

Battery Level: The remaining battery power.

Cadence: The revolutions of the crank arm or strides per minute. Your device must be connected to a cadence accessory.

Cadence - Avg.: The average cadence for the current activity.

Cadence - Lap: The average cadence for the current lap.

Calories: The amount of total calories burned.

Calories - Fat: The amount of fat calories burned. Requires a New Leaf® assessment.

Calories to Go: During a workout, the remaining calories when you are using a calorie target.

Course Pt. Dist.: The remaining distance to the next point on the course.

Dist. - Lap: The distance traveled for the current lap.

Dist. - Last Lap: The distance traveled for the last completed lap.

Dist. to Dest.: The remaining distance to the final destination. You must be navigating for this data to appear.

Dist. to Go: During a workout or course, the remaining distance when you are using a distance target.

Dist. to Next: The remaining distance to the next waypoint on the route. You must be navigating for this data to appear.

Distance: The distance traveled for the current track or activity.

Elevation: The altitude of your current location above or below sea level.

ETA at Destination: The estimated time of day you will reach the final destination (adjusted to the local time of the destination). You must be navigating for this data to appear.

ETA at Next: The estimated time of day you will reach the next waypoint on the route (adjusted to the local time of the waypoint). You must be navigating for this data to appear.

GPS Accuracy: The margin of error for your exact location. For example, your GPS location is accurate to within +/- 12 feet (3.65 m).

GPS Signal Strength: The strength of the GPS satellite signal.

Grade: The calculation of rise (elevation) over run (distance). For example, if for every 10 feet (3 m) you climb you travel 200 feet (60 m), the grade is 5%.

Heading: The direction you are moving.

Heart Rate: Your heart rate in beats per minute (bpm). Your device must be connected to a compatible heart rate monitor.

HR - %HRR: The percentage of heart rate reserve (maximum heart rate minus resting heart rate).

HR - %Max.: The percentage of maximum heart rate.

HR - Avg.: The average heart rate for the current activity.

HR - Avg. %HRR: The average percentage of heart rate reserve (maximum heart rate minus resting heart rate) for the current activity.

HR - Avg. %Max.: The average percentage of maximum heart rate for the current activity.

HR - Lap: The average heart rate for the current lap.

HR - Lap %HRR: The average percentage of heart rate reserve (maximum heart rate minus resting heart rate) for the current lap.

HR - Lap %Max.: The average percentage of maximum heart rate for the current lap.

HR - Last Lap: The average heart rate for the last completed lap.

HR to Go: During a workout, the amount you are above or below the heart rate target.

HR Zone: The current range of heart rate (1 to 5). The default zones are based on your user profile, maximum heart rate, and resting heart rate.

Laps: The number of laps completed for the current activity.

Location at Dest.: The last point on the route or course.

Location at Next: The next point on the route or course.

Odometer: A running tally of distance traveled for all trips. This total does not clear when resetting the trip data.

Power: The current power output in watts.

Power - %FTP: The current power output as a percentage of functional threshold power.

Power - 10s Avg.: The 10-second moving average of power output.

Power - 30s Avg.: The 30-second moving average of power output.

Power - 3s Avg.: The three-second moving average of power output.

Power - Avg.: The average power output for the current activity.

Power - IF: The Intensity Factor™ for the current activity.

Power - kj: The accumulated work performed (power output) in kilojoules.

Power - Lap: The average power output for the current lap.

Power - Last Lap: The average power output for the last completed lap.

Power - Max.: The top power output for the current activity.

Power - NP: The Normalized Power™ for the current activity.

Power - NP Lap: The average Normalized Power for the current lap.

Power - NP Last Lap: The average Normalized Power for the last completed lap.

Power - TSS: The Training Stress Score™ for the current activity.

Power - Watts/kg: The amount of power output in watts per kilogram.

Power Zone: The current range of power output (1 to 7) based on your FTP or custom settings.

Reps to Go: During a workout, the remaining repetitions.

Speed: The current rate of travel.

Speed - Avg.: The average speed for the current activity.

Speed - Lap: The average speed for the current lap.

Speed - Last Lap: The average speed for the last completed lap.

Speed - Max.: The top speed for the current activity.

Speed Zone: The current range of speed (1 to 10). Zones can be set in Garmin Connect.

Sunrise: The time of sunrise based on your GPS position.

Sunset: The time of sunset based on your GPS position.

Temperature: The temperature of the air. Your body temperature affects the temperature sensor.

Time: The stopwatch time for the current activity.

Time - Avg. Lap: The average lap time for the current activity.

Time - Elapsed: The total time recorded. For example, if you start the timer and run for 10 minutes, then stop the timer for 5 minutes, then start the timer and run for 20 minutes, your elapsed time is 35 minutes.

Time - Lap: The stopwatch time for the current lap.

Time - Last Lap: The stopwatch time for the last completed lap.

Time of Day: The current time of day based on your current location and time settings (format, time zone, daylight saving time).

Time to Dest.: The estimated time remaining before you reach the destination. You must be navigating for this data to appear.

Time to Go: During a workout, the remaining time when you are using a time target.

Time to Next: The estimated time remaining before you reach the next waypoint in the route. You must be navigating for this data to appear.

Time to Sunrise: The estimated time remaining before sunrise.

Time to Sunset: The estimated time remaining before sunset.

Total Ascent: The total elevation distance ascended since the last reset.

Total Descent: The total elevation distance descended since the last reset.

Vertical Speed: The rate of ascent or descent over time.

VS - 30S Avg.: The 30-second moving average of vertical speed.

Heart Rate Zone Calculations

Zone	% of Maximum Heart Rate	Perceived Exertion	Benefits
1	50–60%	Relaxed, easy pace, rhythmic breathing	Beginning-level aerobic training, reduces stress
2	60–70%	Comfortable pace, slightly deeper breathing, conversation possible	Basic cardiovascular training, good recovery pace
3	70–80%	Moderate pace, more difficult to hold conversation	Improved aerobic capacity, optimal cardiovascular training
4	80–90%	Fast pace and a bit uncomfortable, breathing forceful	Improved anaerobic capacity and threshold, improved speed
5	90–100%	Sprinting pace, unsustainable for long period of time, labored breathing	Anaerobic and muscular endurance, increased power

Wheel Size and Circumference

The wheel size is marked on both sides of the tire. This is not a comprehensive list. You can also use one of the calculators available on the Internet.

To modify your bike profile, see [page 11](#).

Wheel Size	L (mm)
12 × 1.75	935
14 × 1.5	1020
14 × 1.75	1055

Wheel Size	L (mm)
16 × 1.5	1185
16 × 1.75	1195
18 × 1.5	1340
18 × 1.75	1350
20 × 1.75	1515
20 × 1-3/8	1615
22 × 1-3/8	1770
22 × 1-1/2	1785
24 × 1	1753
24 × 3/4 Tubular	1785
24 × 1-1/8	1795
24 × 1-1/4	1905
24 × 1.75	1890
24 × 2.00	1925
24 × 2.125	1965
26 × 7/8	1920
26 × 1(59)	1913
26 × 1(65)	1952
26 × 1.25	1953
26 × 1-1/8	1970
26 × 1-3/8	2068
26 × 1-1/2	2100
26 × 1.40	2005
26 × 1.50	2010
26 × 1.75	2023
26 × 1.95	2050
26 × 2.00	2055
26 × 2.10	2068
26 × 2.125	2070
26 × 2.35	2083
26 × 3.00	2170
27 × 1	2145
27 × 1-1/8	2155
27 × 1-1/4	2161
27 × 1-3/8	2169
650 × 35A	2090
650 × 38A	2125
650 × 38B	2105
700 × 18C	2070
700 × 19C	2080
700 × 20C	2086
700 × 23C	2096
700 × 25C	2105
700 × 28C	2136
700 × 30C	2170
700 × 32C	2155
700C Tubular	2130
700 × 35C	2168
700 × 38C	2180
700 × 40C	2200

Software License Agreement

BY USING THE DEVICE, YOU AGREE TO BE BOUND BY THE TERMS AND CONDITIONS OF THE FOLLOWING SOFTWARE LICENSE AGREEMENT. PLEASE READ THIS AGREEMENT CAREFULLY.

Garmin Ltd. and its subsidiaries (“Garmin”) grant you a limited license to use the software embedded in this device (the

“Software”) in binary executable form in the normal operation of the product. Title, ownership rights, and intellectual property rights in and to the Software remain in Garmin and/or its third-party providers.

You acknowledge that the Software is the property of Garmin and/or its third-party providers and is protected under the United States of America copyright laws and international copyright treaties. You further acknowledge that the structure, organization, and code of the Software, for which source code is not provided, are valuable trade secrets of Garmin and/or its third-party providers and that the Software in source code form remains a valuable trade secret of Garmin and/or its third-party providers. You agree not to decompile, disassemble, modify, reverse assemble, reverse engineer, or reduce to human readable form the Software or any part thereof or create any derivative works based on the Software. You agree not to export or re-export the Software to any country in violation of the export control laws of the United States of America or the export control laws of any other applicable country.

Index

A

accessories **5, 7, 14**
addresses, finding **9**
alerts **3**
altimeter, calibrating **12**
ANT+ sensors **2**
 pairing **7**
ANT+ sensors **5**
applications **8**
Auto Lap **12**
Auto Pause **11**
auto scroll **12**

B

back to start **9**
backlight **2, 12, 14**
battery
 charging **1**
 maximizing **14**
 replacing **13**
 type **1**
Bluetooth technology **8, 11**
brightness **14**

C

cadence **6**
 alerts **3**
calibrating
 power meter **7**
 touchscreen **14**
calorie, alerts **3**
charging the device **1**
cleaning the device **13**
computer, connecting **8**
coordinates **9**
courses **4, 5**
 deleting **5**
 editing **4, 5**
 loading **4**
customizing the device **11**

D

data
 storing **8**
 transferring **7, 8**
data averaging **6**
data fields **11, 15**
data recording **8, 12**
deleting
 all user data **9, 14**
 history **8**
device
 care **13**
 registration **14**
 resetting **14**
display settings **12**
distance, alerts **3**

E

elevation **12**

F

files, transferring **9**
finding locations **10**
 addresses **10**
 near your location **10**

G

Garmin Connect **3, 7**
 storing data **8**
GPS
 satellite page **12**
 signal **2**
 stopping **12**
GSC 10 **6, 13, 14**

H

heart rate
 alerts **3**
 monitor **5**
 zones **5, 6, 16**
heart rate monitor **13**
 pairing **7**
history **3, 7**
 deleting **8**
 sending to computer **7, 8**

I

icons **2**
initial setup **13**
installing **1, 6**

K

keys **2**

L

language **13**
laps **2**
lifetime athlete **11**
locations **9**
 deleting **10**
 editing **10**
 finding with the map **9**
 searching for **10**
locking, screen **14**

M

maps **4**
 finding locations **9**
 orientation **10**
 purchasing **10**
 settings **10**
 topographical **10**
 zoom **10**
memory card **8**
microSD card. See memory card
mounting the device **1**

N

navigation **9**
 back to start **9**
 stopping **9**

O

O-rings (bands) **13**
on-screen buttons **2**

P

pairing **2**
 heart rate monitor **7**
 pairing ANT+ sensors **7**
personal records **5, 8**
 restoring **5**
points of interest (POI) **10**
 finding **9**
power
 alerts **3**
 zones **7**
power meter **6, 7**
power meters **7**
power save **14**
product registration **14**
profiles **11**
 bike **11**
 user **11**

R

registering the device **14**
replacing battery **13**
resetting the device **14**
restoring, settings **14**
routes, settings **10**

S

satellite page **12**
satellite signals **2**
saving activities **3**

screen. **12** See *also* backlight
 brightness **14**
 locking **14**
settings **2, 10–13**
 device **13**
smart recording **8**
smartphone **2, 8, 11**
software
 updating **14**
 version **14**
software license agreement **14, 16**
specifications **13**
speed, zones **5**
start notice message **12**
storing data **7, 8**
system settings **12**

T

temperature **14**
time, alerts **3**
time settings **13**
time zones **13**
timer **2, 3, 7**
tones **13**
topographical maps **10**
touchscreen, calibrating **14**
training pages, viewing **3**
troubleshooting **14**

U

unit ID **14**
units of measure **12**
updating software **14**
USB, disconnecting **9**
user data, deleting **9**
user profile **2, 11**

V

Virtual Partner **4, 5**

W

water resistance **13**
waypoints, projecting **9**
weight scale **7**
wheel sizes **16**
workouts **3, 4**
 creating **3, 4**
 deleting **4**
 editing **4**
 loading **3**

Z

zones
 power **7**
 speed **5**
 time **13**

www.garmin.com/support



913-397-8200
1-800-800-1020



0808 238 0000
+44 870 850 1242



1-866-429-9296



+43 (0) 820 220 230



+32 2 672 52 54



+45 4810 5050



+358 9 6937 9758



+ 331 55 69 33 99



+49 (0)180 6 427646



+ 39 02 36 699699



0800 - 023 3937
035 - 539 3727



+ 47 815 69 555



00800 4412 454
+44 2380 662 915



+ 35 1214 447 460



+ 34 93 275 44 97



+ 46 7744 52020

Garmin International, Inc.

1200 East 151st Street
Olathe, Kansas 66062, USA

Garmin (Europe) Ltd.

Liberty House, Hounslow Business Park
Southampton, Hampshire, SO40 9LR UK

Garmin Corporation

No. 68, Zhangshu 2nd Road, Xizhi Dist.
New Taipei City, 221, Taiwan (R.O.C.)



M102

